

BAZA DO DOMKU STALOWEGO 9m²

Instrukcja montażu

BASE FOR STEEL HOUSE

Use Instructions

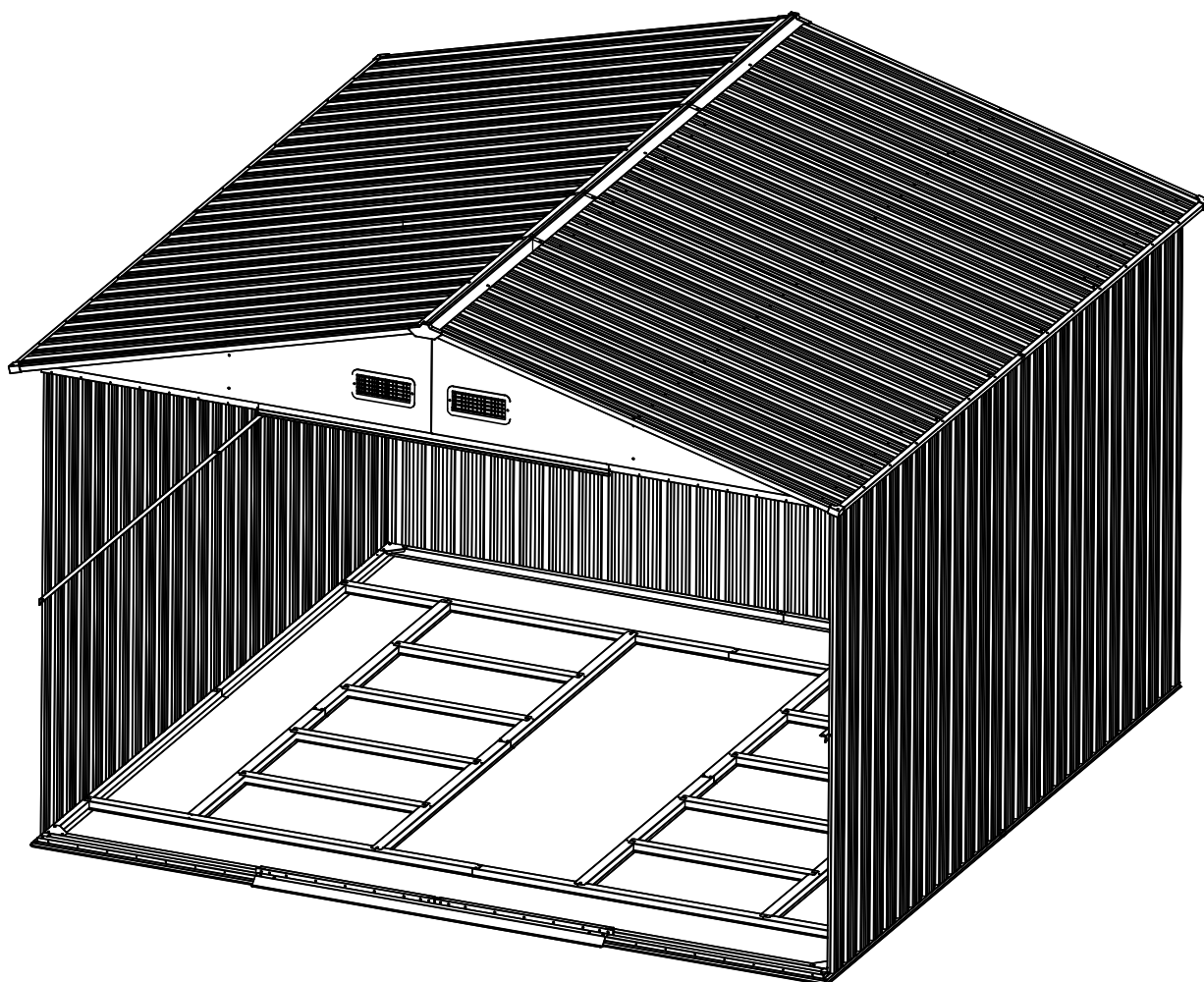

5 904506 715657





4iQ Group sp. zo.o.

ul. Mierostawskiego 6, 14-200 Itawa, Poland

+48 89 674 92 57, kontakt@4iQ.com.pl

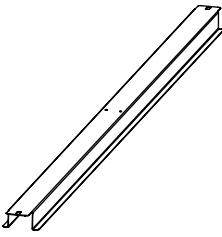
www.4iQ.com.pl

NO./NR.	PART / ELEMENT	QTY./ ILOŚĆ
36		2
37		2
38		4
39		4
40		8
F1		40

36

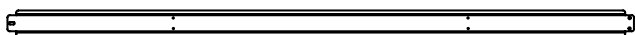

37

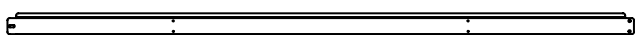
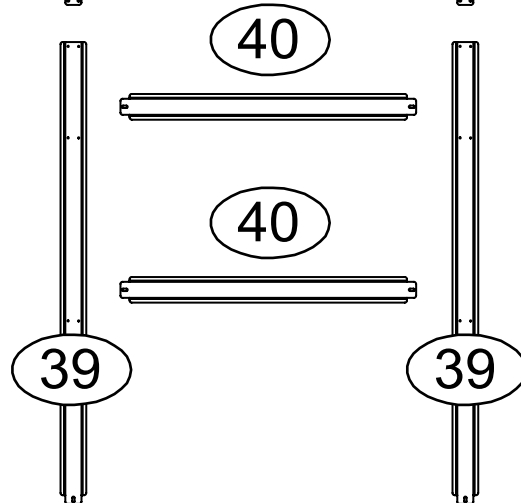
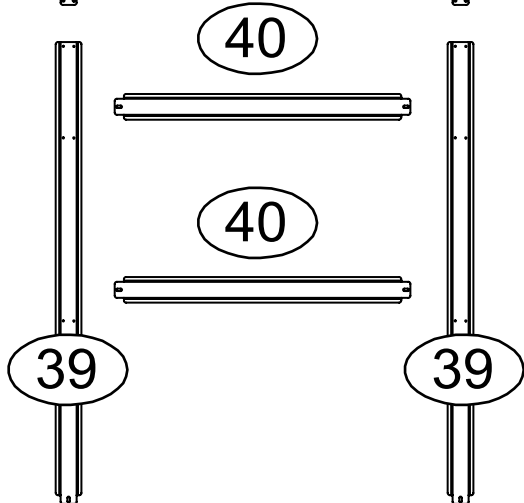
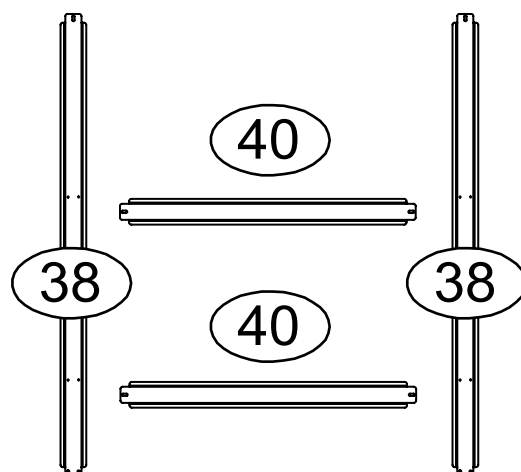
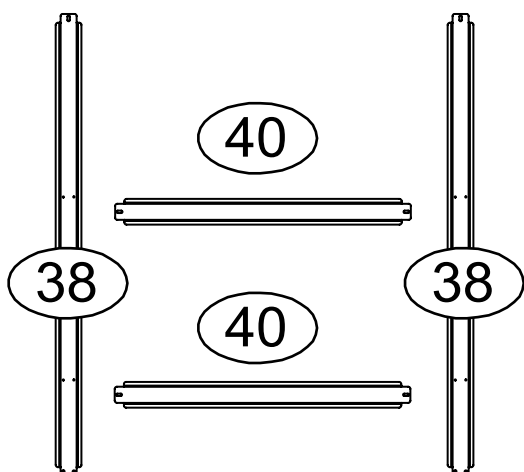

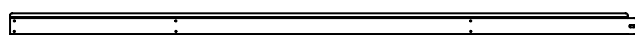

36

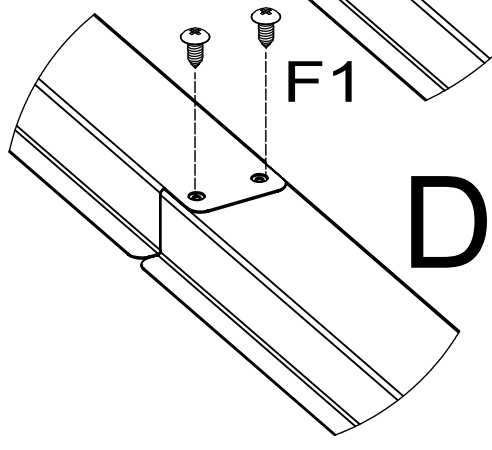
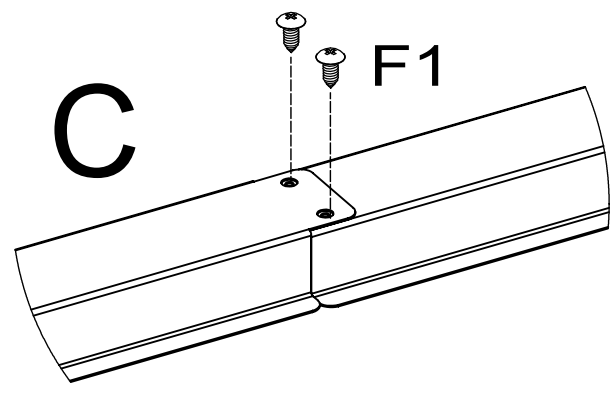
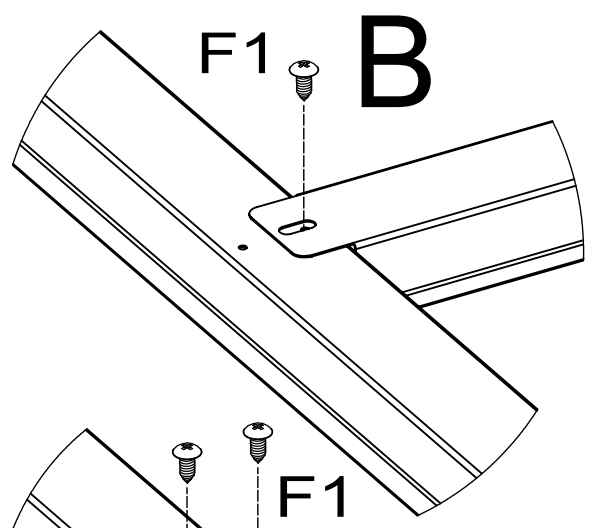
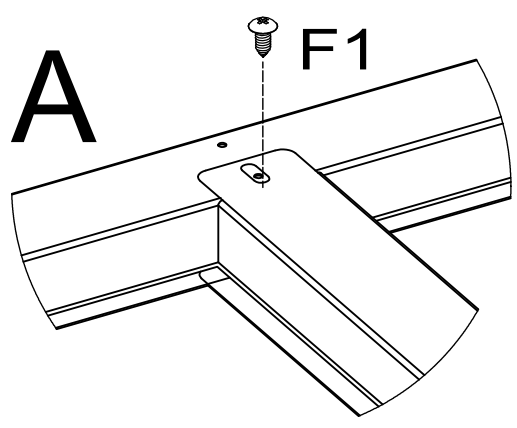
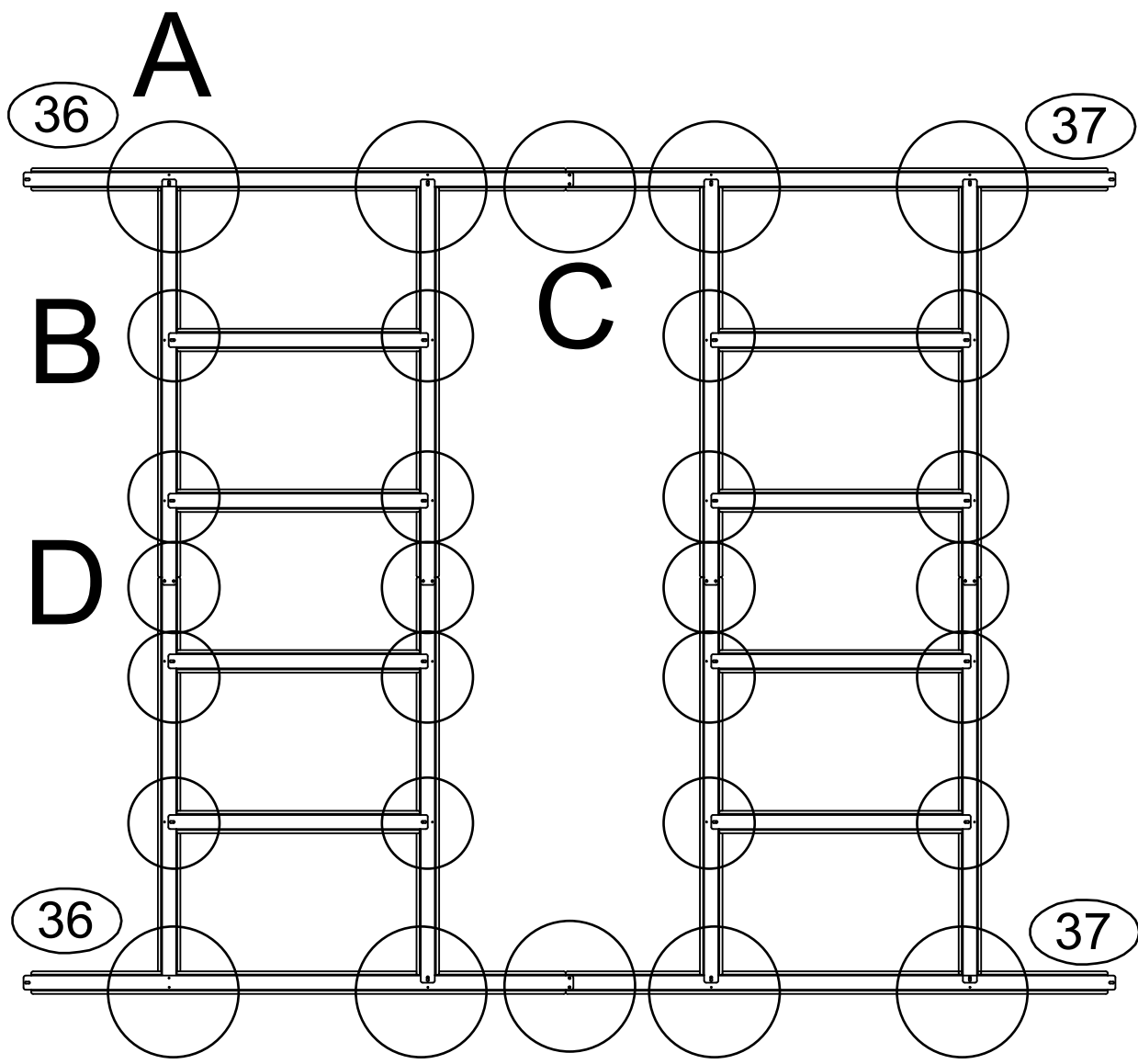

37



NO./NR.	PART/ELEMENT	QTY./ ILOŚĆ
F1		4
36		2
37		2

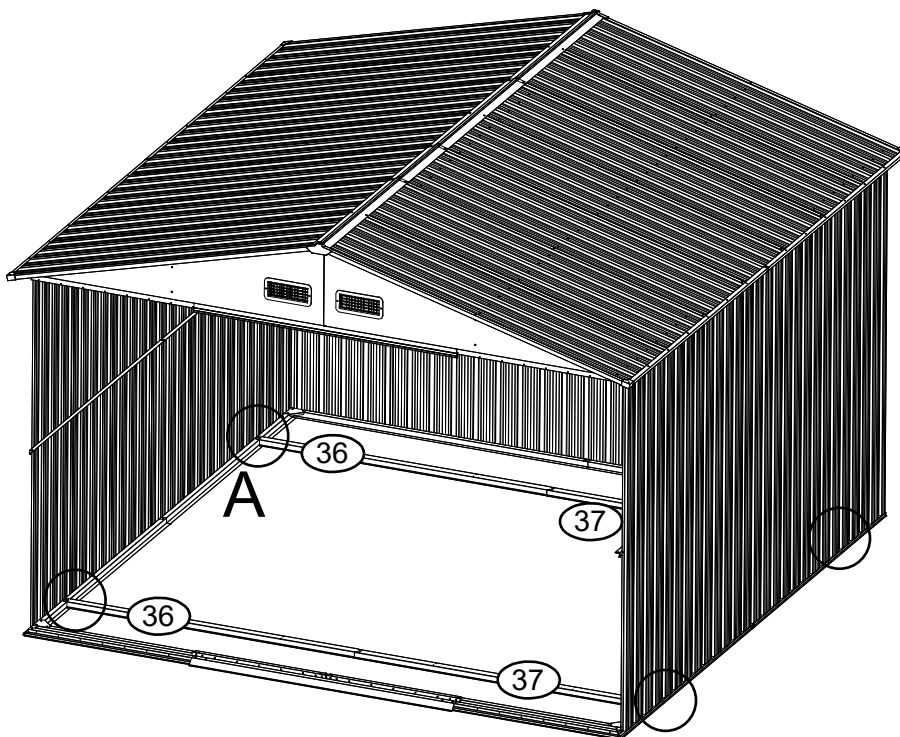
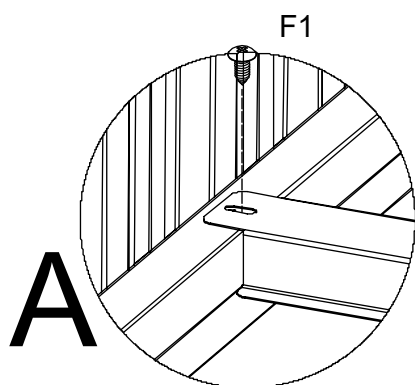

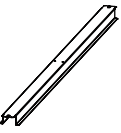
NO./NR.	PART/ELEMENT	QTY./ ILOŚĆ
F1		36
38		4
39		4
40		8

